

JGT300HF120G9H

IGBT Module

Preliminary Data

Features:

- Trench & Field Stop IGBT
- Short Circuit Rated > 10 μ s
- Low Switching Loss
- 100% RBSOA Tested (2X I_c)
- Low Stray Inductance
- Copper Wire Bonding on Power Terminal
- Lead Free, Compliant with RoHS Requirement

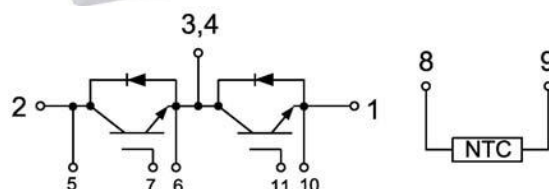

Applications:

- Hybrid Electrical Vehicles(H)EV
- Automotive Applications
- Commercial Agriculture Vehicles
- Motor Drives

IGBT, Inverter

Maximum Rated Values($T_c=25^\circ\text{C}$ unless otherwise specified)

V_{CES}	Collector-Emitter Blocking Voltage		1200	V
V_{GES}	Gate-Emitter Voltage		± 20	V
I_C	Continuous Collector Current	$T_c=100^\circ\text{C}$	300	A
		$T_c=25^\circ\text{C}$	580	A
I_{CM}	Peak Collector Current Repetitive	$T_J=175^\circ\text{C}$	600	A
t_{SC}	Short Circuit Withstand Time		>10	μs
P_D	Maximum Power Dissipation (IGBT)	$T_c=25^\circ\text{C}$ $T_{Jmax}=175^\circ\text{C}$	1975	W

Electrical Characteristics of IGBT ($T_C=25^\circ\text{C}$ unless otherwise specified)

Static Characteristics

Symbol	Description	Conditions	Min	Typ	Max	Unit
$V_{GE(th)}$	Gate-Emitter Threshold Voltage	$I_C=4\text{mA}, V_{CE}=V_{GE}$	5.0	5.6	6.6	V
$V_{CE(sat)}$	Collector-Emitter Saturation Voltage	$I_C=30\text{0A}, V_{GE}=1\text{5V}$	$T_J=25^\circ\text{C}$	1.70	1.90	V
			$T_J=125^\circ\text{C}$	1.90		V
			$T_J=150^\circ\text{C}$	2.00		V
I_{CES}	Collector-Emitter Leakage Current	$V_{GE}=0\text{V}, V_{CE}=V_{CES}, T_J=25^\circ\text{C}$			1	mA
I_{GES}	Gate-Emitter Leakage Current	$V_{GE}=\pm 20\text{V}, V_{CE}=0\text{V}, T_J=25^\circ\text{C}$			400	nA
C_{ies}	Input Capacitance	$V_{CE}=25\text{V}, V_{GE}=0\text{V}, f=1\text{MHz}$		25.2		nF
C_{res}	Reverse Transfer Capacitance			0.86		nF

Switching Characteristics

$t_{d(on)}$	Turn-on Delay Time	$V_{CC}=600\text{V}, I_C=300\text{A}, R_{Gon}=2\Omega, V_{GE}=\pm 15\text{V}, \text{Inductive Load}$	$T_J=25^\circ\text{C}$	0.39	μs
			$T_J=125^\circ\text{C}$	0.40	
			$T_J=150^\circ\text{C}$	0.40	
t_r	Rise Time		$T_J=25^\circ\text{C}$	0.13	μs
			$T_J=125^\circ\text{C}$	0.13	
			$T_J=150^\circ\text{C}$	0.13	
$t_{d(off)}$	Turn-off Delay Time		$T_J=25^\circ\text{C}$	0.39	μs
			$T_J=125^\circ\text{C}$	0.42	
			$T_J=150^\circ\text{C}$	0.42	
t_f	Fall Time	$T_J=25^\circ\text{C}$	0.13	μs	
		$T_J=125^\circ\text{C}$	0.19		
		$T_J=150^\circ\text{C}$	0.21		
E_{on}	Turn-on Switching Loss	$T_J=25^\circ\text{C}$	20.6	mJ	
		$T_J=125^\circ\text{C}$	27.3		
		$T_J=150^\circ\text{C}$	29.7		

E _{off}	Turn-off Switching Loss	V _{CC} = 600V, I _C =300A, R _{Goff} = 2Ω, V _{GE} = ±15V, du/dt=3300V/μs (T _J =150°C) Inductive Load	T _J =25°C	26.7	mJ
			T _J =125°C	35.6	
			T _J =150°C	38.3	
Q _g	Total Gate Charge	V _{GE} =+15V...-15V	T _J =25°C	1.56	μC
R _{g internal}	Internal Gate Resistance		T _J =25°C	2.5	Ω
RBSO A	I _C =600A, V _{CC} =1050V, V _p =1200V, R _{Goff} = 2Ω, V _{GE} =+15V to 0V, T _J =150°C			Trapezoid	
I _{SC}	SC Data	V _{CC} =600V, V _{GE} =±15V, R _{Gon} =2ohm, R _{Goff} =2ohm, tp=10us, T _J =125°C, Inductive Load		1594	A
R _{θJC}	IGBT Thermal Resistance: Junction-To-Case(per leg)			0.076	°C /W

Maximum Rated Values of Diode (T_C=25°C unless otherwise specified)

V _{RRM}	Repetitive Peak Reverse Voltage	1200	V
I _F	Diode Continuous Forward Current	300	A
I _{FM}	Diode Maximum Forward Current	600	A

Electrical Characteristics of Diode (T_C=25°C unless otherwise specified)

Symbol	Description	Conditions	Min	Typ	Max	Unit
V _{FM}	Forward Voltage	I _F =300A	T _J =25°C	1.80		V
			T _J =125°C	1.80		
			T _J =150°C	1.80		
t _{rr}	Reverse Recovery Time		T _J =25°C	0.41		μs
			T _J =125°C	0.60		
			T _J =150°C	0.64		
I _{rr}	Peak Reverse Recovery Current	I _F =300A, -di _F /dt =2010A/μs(T _J =150°C), V _R =600V, V _{GE} = -15V	T _J =25°C	150		A
			T _J =125°C	181		
			T _J =150°C	191		
Q _{rr}	Reverse Recovery Charge		T _J =25°C	29.7		μC
			T _J =125°C	50.7		
			T _J =150°C	57.8		

E _{rec}	Reverse Recovery Energy	I _F =300A, -diF/dt =2010/μs(T _J =150°C), V _R =600V, V _{GE} = -15V	T _J =25°C	12.9	mJ
			T _J =125°C	22.0	
			T _J =150°C	25.4	
R _{θJC}	Diode Thermal Resistance: Junction-To-Case (per leg)			0.134	°C/W

Internal NTC-Thermistor Characteristics

R ₂₅	T _C =25°C	5		kΩ
ΔR/R	T _C =100°C, R ₁₀₀ =481Ω		±5	%
P ₂₅	T _C =25°C	50		mW
B _{25/50}	R ₂ =R ₂₅ exp[B _{25/50} (1/T ₂ -1/(298.15K))]	33 80		K
B _{25/80}	R ₂ =R ₂₅ exp[B _{25/80} (1/T ₂ -1/(298.15K))]	34 40		K

Module

Symbol	Descript		Min	Typ	Max	Unit
V _{iso}	Isolation Voltage (All Terminals Shorted)	f = 50Hz, 1minute	2500			V
L _{sCE}	Stray Inductance Module			20		nH
T _J	Maximum Junction Temperature				175	°C
T _{JOP}	Maximum Operating Junction Temperature Range		-40		+150	°C
T _{stg}	Storage Temperature		-40		+125	°C
CTI	Comparative Tracking Index		200			
R _{θCS}	Case-To-Sink Thermally (Conductive Grease Applied)			0.02		°C/W
M	Power Terminals Screw:M5		3.0		5.0	N·m
M	Mounting Screw:M6		4.0		6.0	N·m
G	Weight			330		g

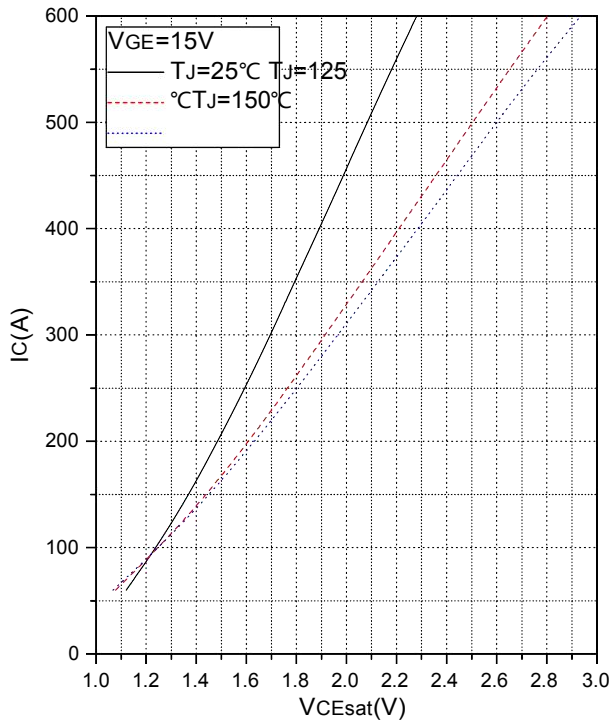

Fig.1 Typical Saturation Voltage Characteristics

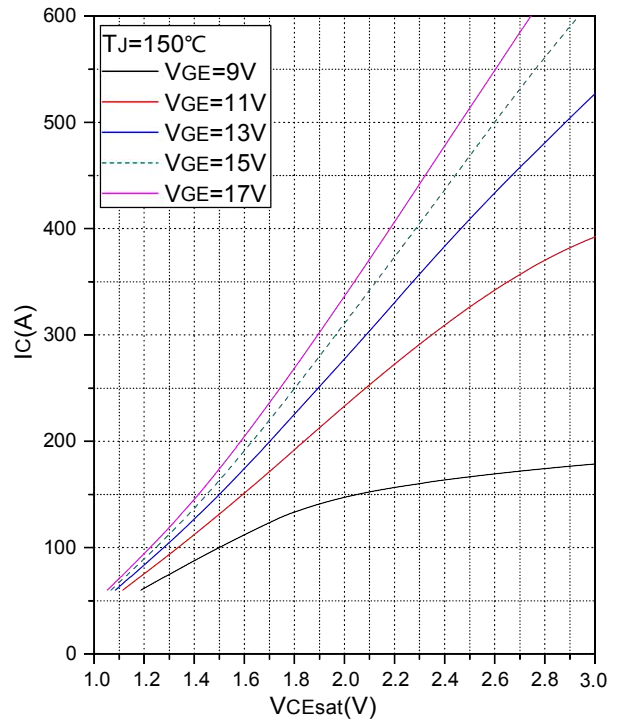

Fig.2 Typical Output Characteristics

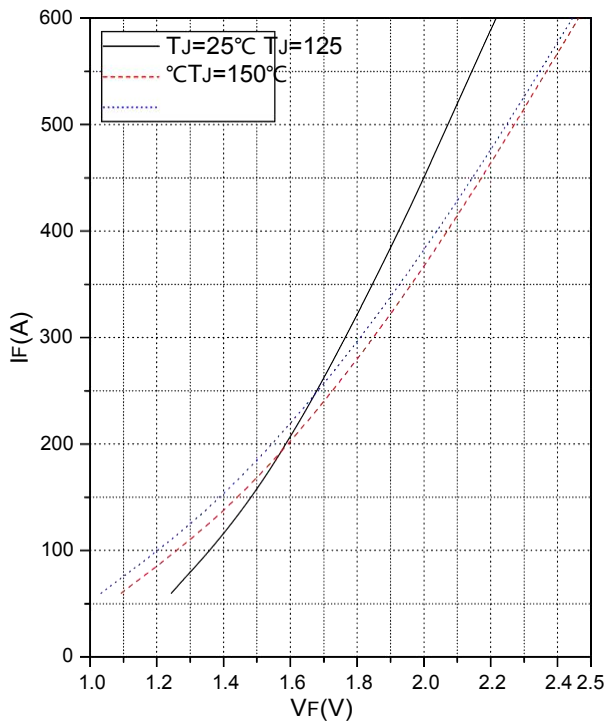

Fig.3 Forward Characteristics of Diode

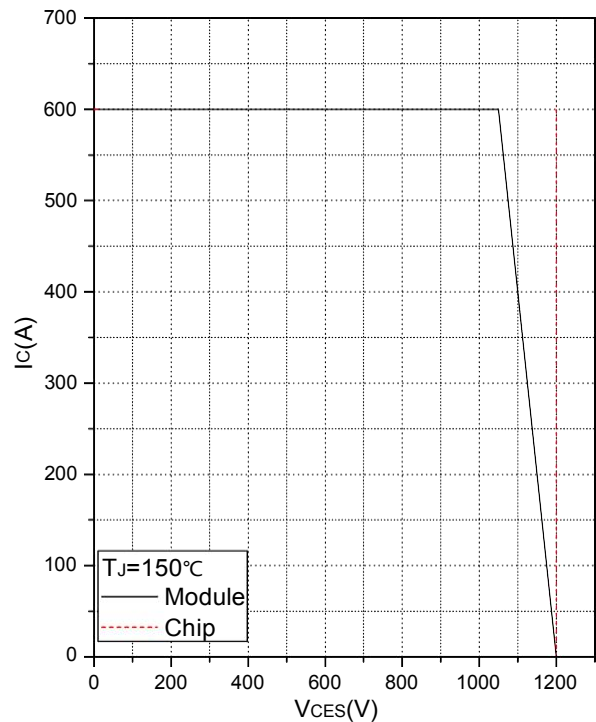

Fig.4 Reverse Bias Safe Operation Area (RBSOA)

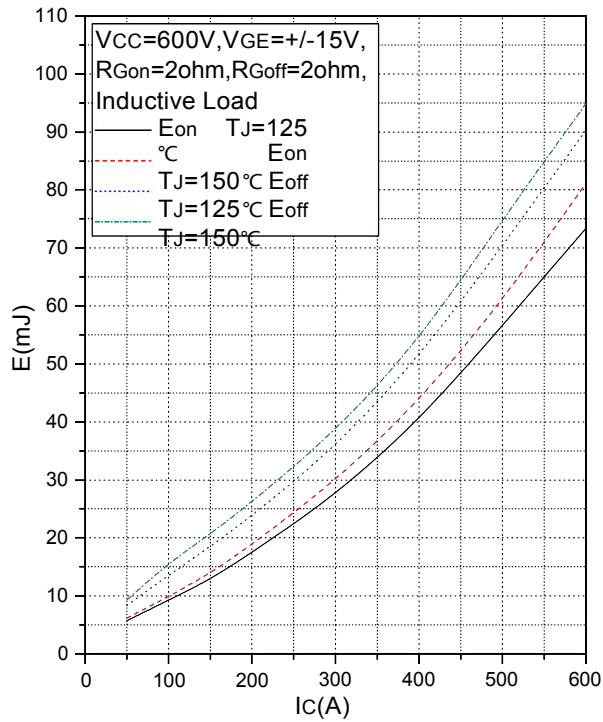

Fig.5 Typical Switching Loss vs. Collector Current

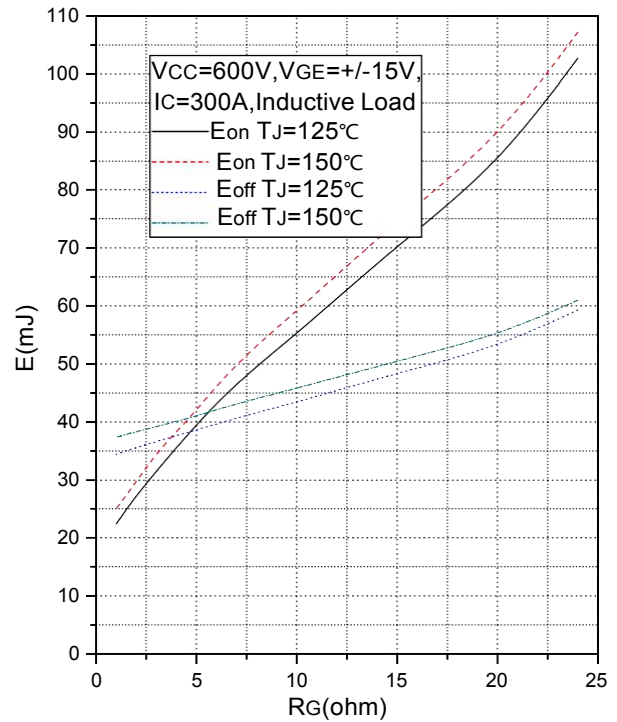

Fig.6 Typical Switching Loss vs. Gate Resistance

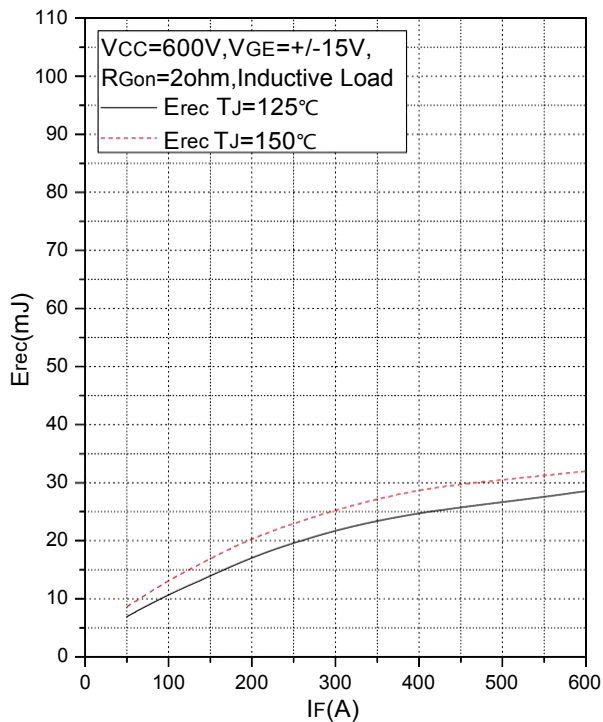

Fig.7 Typical Switching Loss vs. Forward Current

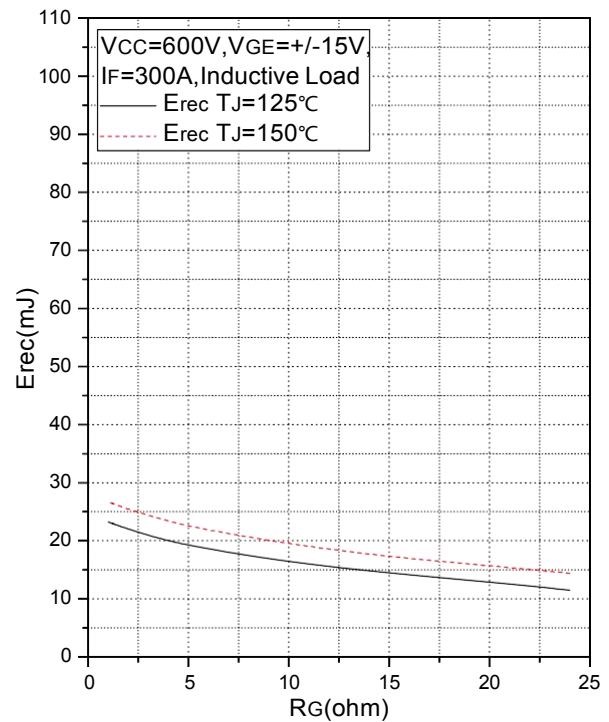

Fig.8 Typical Switching Loss vs. Gate Resistance

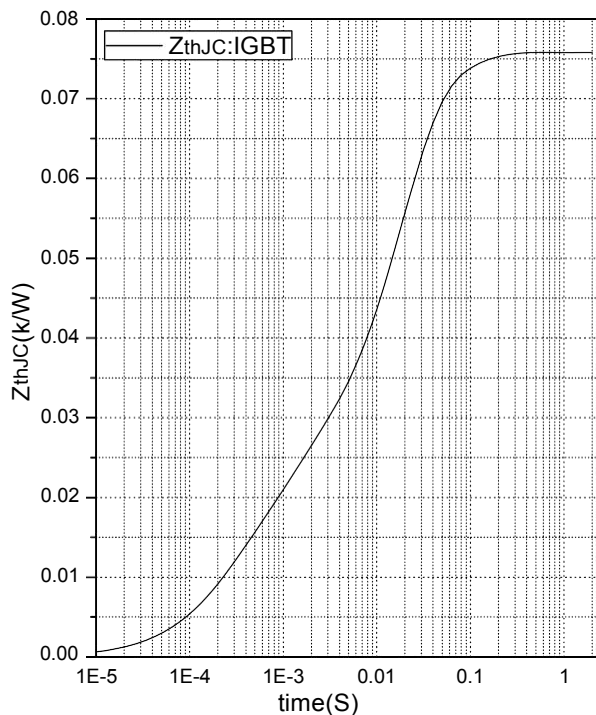

Fig.9 Transient Thermal Impedance (IGBT)

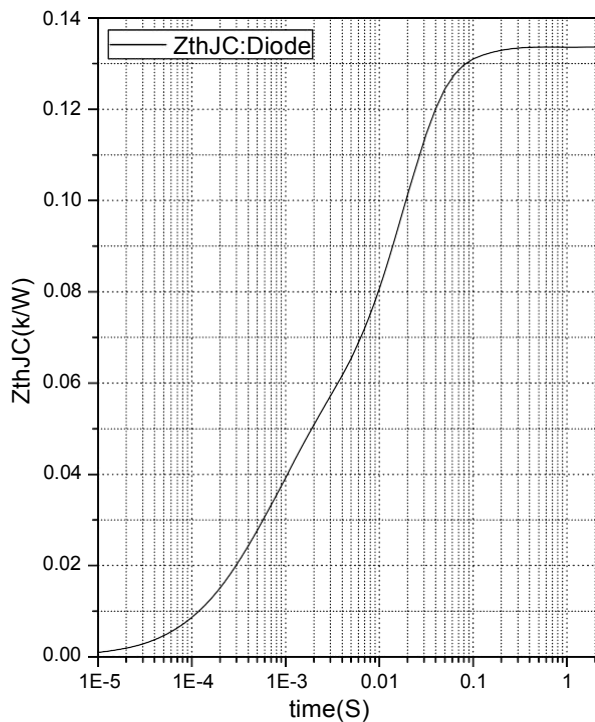

Fig.10 Transient Thermal Impedance (Diode)

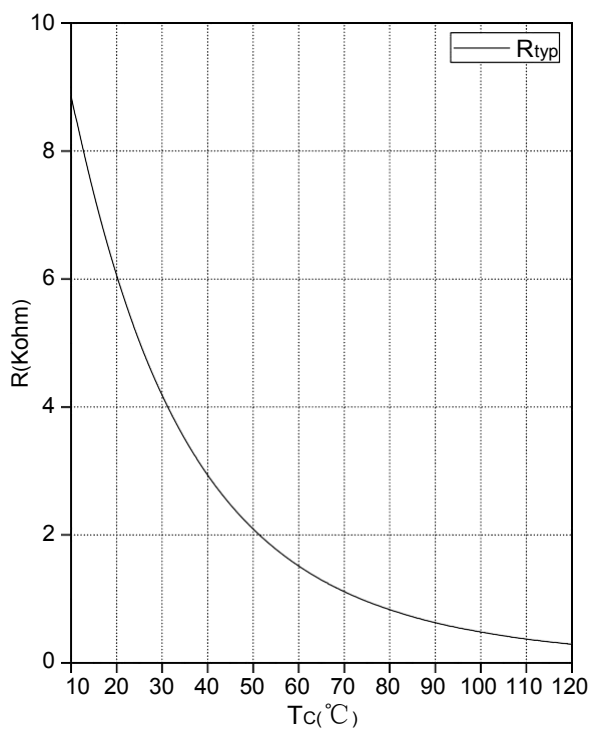
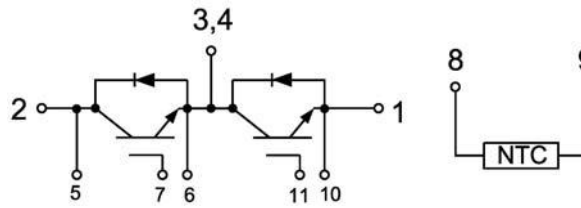
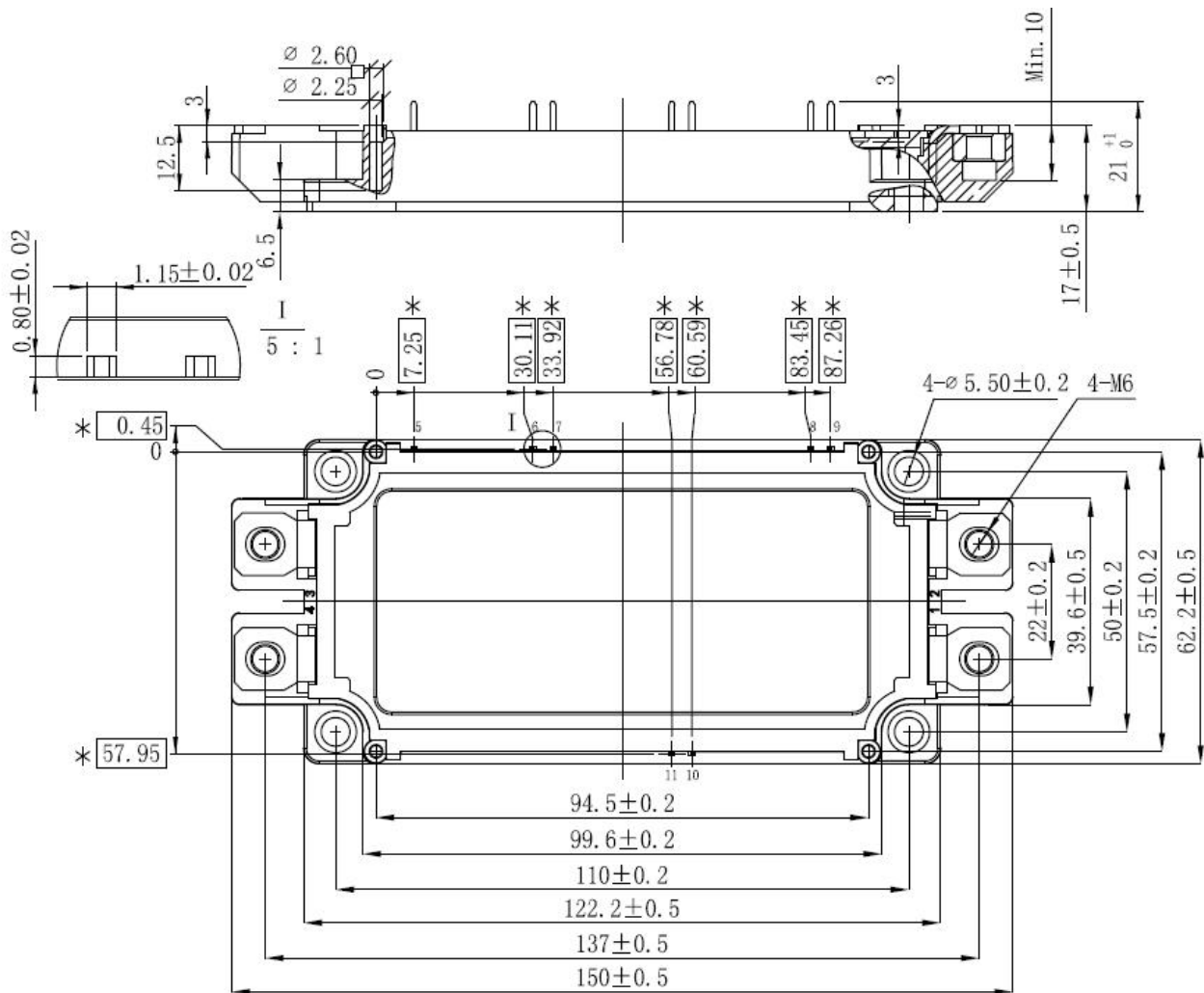

Fig.11 NTC Temperature Characteristics

Internal Circuit:



Package Outline (Unit: mm):





Date	Revision	Notes
04/18/2022	01	Initial Release