

Модульные контакторы и переключатели



Можно использовать как основные или вспомогательные

Установка на 35 мм DIN-реку в соответствии с EN 60715

Индикация положения переключателя

Управление напряжением до 400 В

Катушка управления AC или AC/DC

Низкое потребление тока AC катушки

Бесшумная AC/DC катушка (Hum-Free)

Дополнительные контакты для всех контакторов

Широкий выбор аксессуаров для контакторов

Герметичные клеммные крышки

Класс энергосбережения: IE3

Класс защиты: IP20

Изоляционный корпус предотвращает прикосновение к движущимся и находящимся под напряжением деталям контактора

Функция моментального контроля (как нажимная кнопка) позволяет вручную провести кратковременную импульсную проверку функционала

Auto-On-Off селектор - при подаче сигнала на катушку управления положение клавиши I автоматически перейдет в A

Расшифровка обозначений партномера

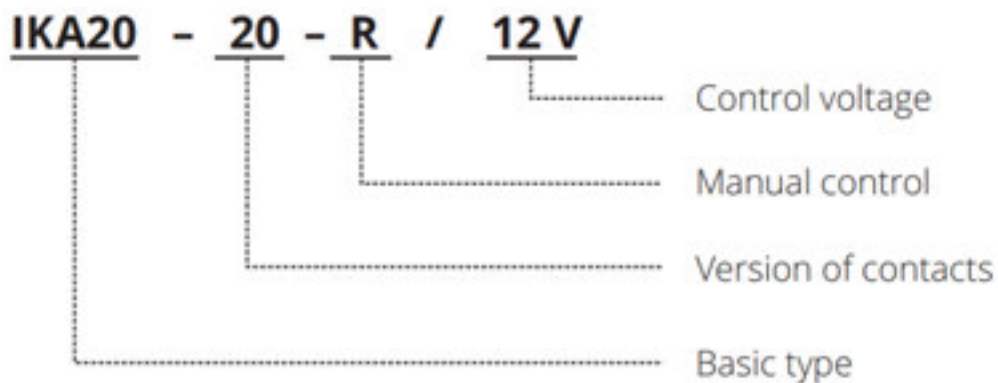

IK и IKA – контакторы с катушкой управления AC

IKD – контакторы с катушкой управления DC

R – с ручным управлением и селектором Auto-On-Off (для контакторов)

T – с ручным управлением и функцией моментального контроля

2P – 2 полюсной контактор шириной в 2 модуля

Список контакторов и положение групп контактов

AC-1 acc. to IEC/EN 60947-4-1 (2-pole, 1 module)

AC

Type	Rated current I_n	Control voltage at 50/60 Hz	Wiring diagram	Ordering No.	Weight (g)	Packaging (pcs)
IKA216-20	16 A	230 V		30.047.486	130	6
IKA216-20	16 A	24 V		30.047.487	130	
IKA20-20	20 A	230 V		30.046.005	130	
IKA20-20	20 A	24 V		30.046.021	130	
IKA225-20	25 A	230 V		30.046.714	130	
IKA225-20	25 A	24 V		30.046.711	130	
IKA232-20	32 A	230 V	30.046.833	130	6	
IKA232-20	32 A	24 V	30.046.834	130		
IKA216-11	16 A	230 V		30.047.488		130
IKA216-11	16 A	24 V		30.047.489		130
IKA20-11	20 A	230 V		30.046.009		130
IKA20-11	20 A	24 V		30.046.022		130
IKA225-11	25 A	230 V		30.046.715	130	
IKA225-11	25 A	24 V		30.046.712	130	
IKA232-11	32 A	230 V	30.046.835	130	6	
IKA232-11	32 A	24 V	30.046.836	130		
IKA216-10	16 A	230 V		30.047.490		125
IKA216-10	16 A	24 V		30.047.491		125
IKA20-10	20 A	230 V		30.046.457		125
IKA20-10	20 A	24 V		30.046.837		125
IKA225-10	25 A	230 V		30.046.713	125	
IKA225-10	25 A	24 V		30.046.710	125	
IKA232-10	32 A	230 V	30.046.838	125	6	
IKA232-10	32 A	24 V	30.046.839	125		
IKA216-01	16 A	230 V		30.047.492		125
IKA216-01	16 A	24 V		30.047.493		125
IKA20-01	20 A	230 V		30.046.716		125
IKA20-01	20 A	24 V		30.046.840		125
IKA225-01	25 A	230 V		30.046.841	125	
IKA225-01	25 A	24 V		30.046.842	125	
IKA232-01	32 A	230 V	30.046.843	125	6	
IKA232-01	32 A	24 V	30.046.844	125		
IKA216-02	16 A	230 V		30.047.494		130
IKA216-02	16 A	24 V		30.047.495		130
IKA20-02	20 A	230 V		30.046.010		130
IKA20-02	20 A	24 V		30.046.023		130
IKA225-02	25 A	230 V		30.046.845	130	
IKA225-02	25 A	24 V		30.046.846	130	
IKA232-02	32 A	230 V	30.046.847	130	6	
IKA232-02	32 A	24 V	30.046.848	130		

AC-1 acc. to IEC/EN 60947-4-1 (1-pole, 1 module)

AC

Type	Rated current I_n	Control voltage at 50/60 Hz	Wiring diagram	Ordering No.	Weight (g)	Packaging (pcs)
IKA140-1P	40 A	230 V		30.047.814	123	6
IKA140-1P	40 A	24 V		30.047.815	123	6

AC-1 acc. to IEC/EN 60947-4-1 (1-pole, 1 module)

AC/DC

Type	Rated current I_n	Control voltage	Wiring diagram	Ordering No.	Weight (g)	Packaging (pcs)
IKD140-1P	40 A	230 V AC 220 V DC		30.047.816	123	6
IKD140-1P	40 A	24 V AC/DC		30.047.817	123	6

AC-1 acc. to IEC/EN 60947-4-1 (4-pole, 2 modules)

Type	Rated current I_n	Control voltage at 50/60 Hz	Wiring diagram	Ordering No.	Weight (g)	Packaging (pcs)
IKA416-40	16 A	230 V		30.047.496	230	3
IKA416-40	16 A	24 V		30.047.497	230	
IKA25-40	25 A	230 V		30.046.007	230	
IKA25-40	25 A	24 V		30.046.027	230	
IKA432-40	32 A	230 V		30.046.849	230	
IKA432-40	32 A	24 V		30.046.850	230	
IKA416-31	16 A	230 V		30.047.498	230	3
IKA416-31	16 A	24 V		30.047.499	230	
IKA25-31	25 A	230 V		30.046.013	230	
IKA25-31	25 A	24 V		30.046.028	230	
IKA432-31	32 A	230 V		30.046.851	230	
IKA432-31	32 A	24 V		30.046.852	230	
IKA416-30	16 A	230 V		30.047.500	225	3
IKA416-30	16 A	24 V		30.047.501	225	
IKA25-30	25 A	230 V		30.046.282	225	
IKA25-30	25 A	24 V		30.046.853	225	
IKA432-30	32 A	230 V		30.046.854	225	
IKA432-30	32 A	24 V		30.046.855	225	
IKA416-22	16 A	230 V		30.047.502	230	3
IKA416-22	16 A	24 V		30.047.503	230	
IKA25-22	25 A	230 V		30.046.014	230	
IKA25-22	25 A	24 V		30.046.029	230	
IKA432-22	32 A	230 V		30.046.856	230	
IKA432-22	32 A	24 V		30.046.857	230	
IKA416-04	16 A	230 V		30.047.504	230	3
IKA416-04	16 A	24 V		30.047.505	230	
IKA25-04	25 A	230 V		30.046.015	230	
IKA25-04	25 A	24 V		30.046.030	230	
IKA432-04	32 A	230 V		30.046.858	230	
IKA432-04	32 A	24 V		30.046.859	230	

AC

AC-1 acc. to IEC/EN 60947-4-1 (2-pole, 2 modules)

Type	Rated current I_n	Control voltage at 50/60 Hz	Wiring diagram	Ordering No.	Weight (g)	Packaging (pcs)
IKA240-2P	40 A	230 V		30.047.735	220	3
IKA240-2P	40 A	24 V		30.047.811	220	3

AC

AC-1 acc. to IEC/EN 60947-4-1 (2-pole, 2 modules)

Type	Rated current I_n	Control voltage	Wiring diagram	Ordering No.	Weight (g)	Packaging (pcs)
IKD240-2P	40 A	230 V AC 220 V DC		30.047.812	220	3
IKD240-2P	40 A	24 V AC/DC		30.047.813	220	3

AC/DC

AC-1 acc. to IEC/EN 60947-4-1 (4-pole, 3 modules)

AC

Type	Rated current I_n	Control voltage at 50/60 Hz	Wiring diagram	Ordering No.	Weight (g)	Packaging (pcs)
IKA40-40	40 A	230 V		30.045.518	350	5
IKA40-40	40 A	24 V		30.045.595	350	
IKA63-40	63 A	230 V		30.045.522	350	5
IKA63-40	63 A	24 V		30.045.596	350	
IKA40-31	40 A	230 V		30.045.597	350	5
IKA40-31	40 A	24 V		30.045.598	350	
IKA63-31	63 A	230 V		30.045.533	350	
IKA63-31	63 A	24 V		30.045.599	350	
IKA40-30	40 A	230 V		30.045.517	340	5
IKA40-30	40 A	24 V		30.045.600	340	
IKA63-30	63 A	230 V		30.045.521	340	
IKA63-30	63 A	24 V		30.045.601	340	
IKA40-22	40 A	230 V		30.045.519	350	5
IKA40-22	40 A	24 V		30.045.602	350	
IKA63-22	63 A	230 V		30.045.523	350	
IKA63-22	63 A	24 V		30.045.603	350	
IKA40-04	40 A	230 V		30.045.511	350	5
IKA40-04	40 A	24 V		30.045.604	350	
IKA63-04	63 A	230 V		30.045.605	350	
IKA63-04	63 A	24 V		30.045.606	350	

AC-1 acc. to IEC/EN 60947-4-1 (4-pole, 2 modules)

AC

Type	Rated current I_n	Control voltage at 50/60 Hz	Wiring diagram	Ordering No.	Weight (g)	Packaging (pcs)
IK21-10	20 A	220-240 V		30.041.246	170	10
IK21-10	20 A	24 V		30.041.008	170	
IK21-01	20 A	220-240 V		30.041.245	170	10
IK21-01	20 A	24 V		30.041.249	170	

AC-1 acc. to IEC/EN 60947-4-1 (2-pole, 1 module)

AC/DC

Type	Rated current I _n	Control voltage	Wiring diagram	Ordering No.	Weight (g)	Packaging (pcs)
IKD216-20	16 A	230 V AC 220 V DC		30.047.506	130	6
IKD216-20	16 A	24 V AC/DC		30.047.507	130	
IKD20-20	20 A	230 V AC 220 V DC		30.046.006	130	
IKD20-20	20 A	24 V AC/DC		30.046.024	130	
IKD225-20	25 A	230 V AC 220 V DC		30.046.860	130	
IKD225-20	25 A	24 V AC/DC		30.046.861	130	
IKD232-20	32 A	230 V AC 220 V DC		30.046.862	130	6
IKD232-20	32 A	24 V AC/DC		30.046.863	130	
IKD216-11	16 A	230 V AC 220 V DC		30.047.508	130	
IKD216-11	16 A	24 V AC/DC		30.047.509	130	
IKD20-11	20 A	230 V AC 220 V DC		30.046.011	130	
IKD20-11	20 A	24 V AC/DC		30.046.025	130	
IKD225-11	25 A	230 V AC 220 V DC		30.046.864	130	6
IKD225-11	25 A	24 V AC/DC		30.046.865	130	
IKD232-11	32 A	230 V AC 220 V DC		30.046.866	130	
IKD232-11	32 A	24 V AC/DC		30.046.867	130	
IKD216-10	16 A	230 V AC 220 V DC		30.047.510	125	
IKD216-10	16 A	24 V AC/DC		30.047.511	125	
IKD20-10	20 A	230 V AC 220 V DC		30.046.868	125	6
IKD20-10	20 A	24 V AC/DC		30.046.590	125	
IKD225-10	25 A	230 V AC 220 V DC		30.046.869	125	
IKD225-10	25 A	24 V AC/DC		30.046.870	125	
IKD232-10	32 A	230 V AC 220 V DC		30.046.871	125	
IKD232-10	32 A	24 V AC/DC		30.046.872	125	
IKD216-01	16 A	230 V AC 220 V DC		30.047.512	125	6
IKD216-01	16 A	24 V AC/DC		30.047.513	125	
IKD20-01	20 A	230 V AC 220 V DC		30.046.873	125	
IKD20-01	20 A	24 V AC/DC		30.046.874	125	
IKD225-01	25 A	230 V AC 220 V DC		30.046.875	125	
IKD225-01	25 A	24 V AC/DC		30.046.876	125	
IKD232-01	32 A	230 V AC 220 V DC		30.046.877	125	6
IKD232-01	32 A	24 V AC/DC		30.046.878	125	
IKD216-02	16 A	230 V AC 220 V DC		30.047.514	130	
IKD216-02	16 A	24 V AC/DC		30.047.515	130	
IKD20-02	20 A	230 V AC 220 V DC		30.046.012	130	
IKD20-02	20 A	24 V AC/DC		30.046.026	130	
IKD225-02	25 A	230 V AC 220 V DC		30.046.879	130	6
IKD225-02	25 A	24 V AC/DC		30.046.880	130	
IKD232-02	32 A	230 V AC 220 V DC		30.046.881	130	
IKD232-02	32 A	24 V AC/DC		30.046.882	130	

AC-1 acc. to IEC/EN 60947-4-1 (4-pole, 2 modules)

AC/DC

Type	Rated current I_n	Control voltage	Wiring diagram	Ordering No.	Weight (g)	Packaging (pcs)
IKD416-40	16 A	230 V AC 220 V DC		30.047.516	250	
IKD416-40	16 A	24 V AC/DC		30.047.517	250	
IKD25-40	25 A	230 V AC 220 V DC		30.046.008	250	3
IKD25-40	25 A	24 V AC/DC		30.046.031	250	
IKD432-40	32 A	230 V AC 220 V DC		30.046.883	250	
IKD432-40	32 A	24 V AC/DC		30.046.884	250	
IKD416-31	16 A	230 V AC 220 V DC		30.047.518	250	
IKD416-31	16 A	24 V AC/DC		30.047.519	250	
IKD25-31	25 A	230 V AC 220 V DC		30.046.016	250	3
IKD25-31	25 A	24 V AC/DC		30.046.032	250	
IKD432-31	32 A	230 V AC 220 V DC		30.046.885	250	
IKD432-31	32 A	24 V AC/DC		30.046.886	250	
IKD416-30	16 A	230 V AC 220 V DC		30.047.520	245	
IKD416-30	16 A	24 V AC/DC		30.047.521	245	
IKD25-30	25 A	230 V AC 220 V DC		30.046.887	245	3
IKD25-30	25 A	24 V AC/DC		30.046.888	245	
IKD432-30	32 A	230 V AC 220 V DC		30.046.889	245	
IKD432-30	32 A	24 V AC/DC		30.046.890	245	
IKD416-22	16 A	230 V AC 220 V DC		30.047.522	250	
IKD416-22	16 A	24 V AC/DC		30.047.523	250	
IKD25-22	25 A	230 V AC 220 V DC		30.046.017	250	3
IKD25-22	25 A	24 V AC/DC		30.046.033	250	
IKD432-22	32 A	230 V AC 220 V DC		30.046.891	250	
IKD432-22	32 A	24 V AC/DC		30.046.892	250	
IKD416-04	16 A	230 V AC 220 V DC		30.047.524	250	
IKD416-04	16 A	24 V AC/DC		30.047.525	250	
IKD25-04	25 A	230 V AC 220 V DC		30.046.018	250	3
IKD25-04	25 A	24 V AC/DC		30.046.034	250	
IKD432-04	32 A	230 V AC 220 V DC		30.046.893	250	
IKD432-04	32 A	24 V AC/DC		30.046.894	250	

AC-1 acc. to IEC/EN 60947-4-1 (4-pole, 3 modules)

AC

Type	Rated current I _n	Control voltage	Wiring diagram	Ordering No.	Weight (g)	Packaging (pcs)
IK40-40	40 A	230 V AC 220 V DC		30.045.010	420	5
IK40-40	40 A	24 V AC/DC		30.045.022	420	
IK63-40	63 A	230 V AC 220 V DC		30.045.011	420	5
IK63-40	63 A	24 V AC/DC		30.045.187	420	
IK40-31	40 A	230 V AC 220 V DC		30.045.086	420	5
IK40-31	40 A	24 V AC/DC		30.045.485	420	
IK63-31	63 A	230 V AC 220 V DC		30.045.087	420	5
IK63-31	63 A	24 V AC/DC		30.045.234	420	
IK40-30	40 A	230 V AC 220 V DC		30.045.368	410	5
IK40-30	40 A	24 V AC/DC		30.045.607	410	
IK63-30	63 A	230 V AC 220 V DC		30.045.608	410	5
IK63-30	63 A	24 V AC/DC		30.045.609	410	
IK40-22	40 A	230 V AC 220 V DC		30.045.150	420	5
IK40-22	40 A	24 V AC/DC		30.045.172	420	
IK63-22	63 A	230 V AC 220 V DC		30.045.235	420	5
IK63-22	63 A	24 V AC/DC		30.045.233	420	
IK40-04	40 A	230 V AC 220 V DC		30.045.145	420	5
IK40-04	40 A	24 V AC/DC		30.045.232	420	
IK63-04	50 A	230 V AC 220 V DC		30.045.610	420	5
IK63-04	50 A	24 V AC/DC		30.045.611	420	

Type	Rated current I _n	Control voltage at 50/60 Hz	Wiring diagram	Ordering No.	Weight (g)	Packaging (pcs)
IKA216-20-R	16 A	230 V		30.047.526	130	6
IKA216-20-R	16 A	24 V		30.047.527	130	
IKA20-20-R	20 A	230 V		30.046.265	130	
IKA20-20-R	20 A	24 V		30.046.268	130	
IKA225-20-R	25 A	230 V		30.046.895	130	
IKA225-20-R	25 A	24 V		30.046.896	130	
IKA232-20-R	32 A	230 V	30.046.897	130		
IKA232-20-R	32 A	24 V	30.046.898	130		
IKA216-11-R	16 A	230 V		30.047.528	130	6
IKA216-11-R	16 A	24 V		30.047.529	130	
IKA20-11-R	20 A	230 V		30.046.266	130	
IKA20-11-R	20 A	24 V		30.046.269	130	
IKA225-11-R	25 A	230 V		30.046.899	130	
IKA225-11-R	25 A	24 V		30.046.900	130	
IKA232-11-R	32 A	230 V	30.046.901	130		
IKA232-11-R	32 A	24 V	30.046.902	130		
IKA216-10-R	16 A	230 V		30.047.530	125	6
IKA216-10-R	16 A	24 V		30.047.531	125	
IKA20-10-R	20 A	230 V		30.046.496	125	
IKA20-10-R	20 A	24 V		30.046.903	125	
IKA225-10-R	25 A	230 V		30.046.904	125	
IKA225-10-R	25 A	24 V		30.046.905	125	
IKA232-10-R	32 A	230 V	30.046.906	125		
IKA232-10-R	32 A	24 V	30.046.907	125		
IKA216-01-R	16 A	230 V		30.047.532	125	6
IKA216-01-R	16 A	24 V		30.047.533	125	
IKA20-01-R	20 A	230 V		30.046.908	125	
IKA20-01-R	20 A	24 V		30.046.909	125	
IKA225-01-R	25 A	230 V		30.046.910	125	
IKA225-01-R	25 A	24 V		30.046.911	125	
IKA232-01-R	32 A	230 V	30.046.912	125		
IKA232-01-R	32 A	24 V	30.046.913	125		
IKA216-02-R	16 A	230 V		30.047.534	130	6
IKA216-02-R	16 A	24 V		30.047.535	130	
IKA20-02-R	20 A	230 V		30.046.267	130	
IKA20-02-R	20 A	24 V		30.046.270	130	
IKA225-02-R	25 A	230 V		30.046.914	130	
IKA225-02-R	25 A	24 V		30.046.915	130	
IKA232-02-R	32 A	230 V	30.046.916	130		
IKA232-02-R	32 A	24 V	30.046.917	130		

AC-1 acc. to IEC/EN 60947-4-1 (4-pole, 2 modules)

AC

Type	Rated current I _n	Control voltage at 50/60 Hz	Wiring diagram	Ordering No.	Weight (g)	Packaging (pcs)
IKA416-40-R	16 A	230 V		30.047.536	230	3
IKA416-40-R	16 A	24 V		30.047.537	230	
IKA25-40-R	25 A	230 V		30.046.271	230	
IKA25-40-R	25 A	24 V		30.046.275	230	
IKA432-40-R	32 A	230 V		30.046.918	230	
IKA432-40-R	32 A	24 V		30.046.919	230	
IKA416-31-R	16 A	230 V		30.047.538	230	3
IKA416-31-R	16 A	24 V		30.047.539	230	
IKA25-31-R	25 A	230 V		30.046.272	230	
IKA25-31-R	25 A	24 V		30.046.276	230	
IKA432-31-R	32 A	230 V		30.046.920	230	
IKA432-31-R	32 A	24 V		30.046.921	230	
IKA416-30-R	16 A	230 V		30.047.540	225	3
IKA416-30-R	16 A	24 V		30.047.541	225	
IKA25-30-R	25 A	230 V		30.046.922	225	
IKA25-30-R	25 A	24 V		30.046.923	225	
IKA432-30-R	32 A	230 V		30.046.924	225	
IKA432-30-R	32 A	24 V		30.046.925	225	
IKA416-22-R	16 A	230 V		30.047.542	230	3
IKA416-22-R	16 A	24 V		30.047.543	230	
IKA25-22-R	25 A	230 V		30.046.273	230	
IKA25-22-R	25 A	24 V		30.046.277	230	
IKA432-22-R	32 A	230 V		30.046.926	230	
IKA432-22-R	32 A	24 V		30.046.927	230	
IKA416-04-R	16 A	230 V		30.047.544	230	3
IKA416-04-R	16 A	24 V		30.047.545	230	
IKA25-04-R	25 A	230 V		30.046.274	230	
IKA25-04-R	25 A	24 V		30.046.278	230	
IKA432-04-R	32 A	230 V		30.046.928	230	
IKA432-04-R	32 A	24 V		30.046.929	230	

General Use acc. to UL 60947-4-1 (4-pole, 3 modules)

AC

Type	Rated current I _n	Control voltage at 50/60 Hz	Wiring diagram	Ordering No.	Weight (g)	Packaging (pcs)	
IKA40-40-R	40 A	230 V		30.045.506	350	5	
IKA40-40-R	40 A	24 V		30.045.741	350		
IKA63-40-R	63 A	230 V		30.045.508	350		
IKA63-40-R	63 A	24 V		30.045.742	350		
IKA40-31-R	40 A	230 V		30.045.743	350		5
IKA40-31-R	40 A	24 V		30.045.744	350		
IKA63-31-R	63 A	230 V		30.045.745	350		
IKA63-31-R	63 A	24 V		30.045.746	350		
IKA40-22-R	40 A	230 V		30.045.747	350		
IKA40-22-R	40 A	24 V		30.045.748	350		
IKA63-22-R	63 A	230 V		30.045.749	350	5	
IKA63-22-R	63 A	24 V		30.045.750	350		
IKA40-04-R	40 A	230 V		30.045.751	350		
IKA40-04-R	40 A	24 V		30.045.752	350		
IKA63-04-R	63 A	230 V		30.045.753	350		
IKA63-04-R	63 A	24 V		30.045.754	350		



AC-1 acc. to IEC/EN 60947-4-1 (2-pole, 1 module)

AC/DC

Type	Rated current I_n	Control voltage	Wiring diagram	Ordering No.	Weight (g)	Packaging (pcs)
IKD216-20-R	16 A	230 V AC 220 V DC		30.047.546	130	6
IKD216-20-R	16 A	24 V AC/DC		30.047.547	130	
IKD20-20-R	20 A	230 V AC 220 V DC		30.046.381	130	
IKD20-20-R	20 A	24 V AC/DC		30.046.506	130	
IKD225-20-R	25 A	230 V AC 220 V DC		30.046.930	130	
IKD225-20-R	25 A	24 V AC/DC		30.046.931	130	
IKD232-20-R	32 A	230 V AC 220 V DC		30.046.932	130	6
IKD232-20-R	32 A	24 V AC/DC		30.046.933	130	
IKD216-11-R	16 A	230 V AC 220 V DC		30.047.548	130	
IKD216-11-R	16 A	24 V AC/DC		30.047.549	130	
IKD20-11-R	20 A	230 V AC 220 V DC		30.046.507	130	
IKD20-11-R	20 A	24 V AC/DC		30.046.508	130	
IKD225-11-R	25 A	230 V AC 220 V DC	30.046.934	130		
IKD225-11-R	25 A	24 V AC/DC	30.046.935	130		
IKD232-11-R	32 A	230 V AC 220 V DC		30.046.936	130	6
IKD232-11-R	32 A	24 V AC/DC		30.046.937	130	
IKD216-10-R	16 A	230 V AC 220 V DC		30.047.550	125	
IKD216-10-R	16 A	24 V AC/DC		30.047.551	125	
IKD20-10-R	20 A	230 V AC 220 V DC		30.046.938	125	
IKD20-10-R	20 A	24 V AC/DC		30.046.939	125	
IKD225-10-R	25 A	230 V AC 220 V DC	30.046.940	125		
IKD225-10-R	25 A	24 V AC/DC	30.046.941	125		
IKD232-10-R	32 A	230 V AC 220 V DC		30.046.942	125	6
IKD232-10-R	32 A	24 V AC/DC		30.046.943	125	
IKD216-01-R	16 A	230 V AC 220 V DC		30.047.552	125	
IKD216-01-R	16 A	24 V AC/DC		30.047.553	125	
IKD20-01-R	20 A	230 V AC 220 V DC		30.046.944	125	
IKD20-01-R	20 A	24 V AC/DC		30.046.945	125	
IKD225-01-R	25 A	230 V AC 220 V DC	30.046.946	125		
IKD225-01-R	25 A	24 V AC/DC	30.046.947	125		
IKD232-01-R	32 A	230 V AC 220 V DC		30.046.948	125	6
IKD232-01-R	32 A	24 V AC/DC		30.046.949	125	
IKD216-02-R	16 A	230 V AC 220 V DC		30.047.554	130	
IKD216-02-R	16 A	24 V AC/DC		30.047.555	130	
IKD20-02-R	20 A	230 V AC 220 V DC		30.046.950	130	
IKD20-02-R	20 A	24 V AC/DC		30.046.951	130	
IKD225-02-R	25 A	230 V AC 220 V DC	30.046.952	130		
IKD225-02-R	25 A	24 V AC/DC	30.046.953	130		
IKD232-02-R	32 A	230 V AC 220 V DC		30.046.954	130	6
IKD232-02-R	32 A	24 V AC/DC		30.046.955	130	

AC-1 acc. to IEC/EN 60947-4-1 (4-pole, 2 modules)

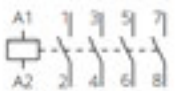
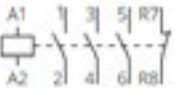
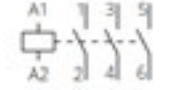
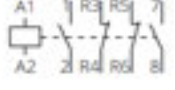
AC/DC

Type	Rated current I _n	Control voltage	Wiring diagram	Ordering No.	Weight (g)	Packaging (pcs)
IKD416-40-R	16 A	230 V AC 220 V DC		30.047.556	250	
IKD416-40-R	16 A	24 V AC/DC		30.047.557	250	
IKD25-40-R	25 A	230 V AC 220 V DC		30.046.509	250	3
IKD25-40-R	25 A	24 V AC/DC		30.046.510	250	
IKD432-40-R	32 A	230 V AC 220 V DC		30.046.956	250	
IKD432-40-R	32 A	24 V AC/DC		30.046.957	250	
IKD416-31-R	16 A	230 V AC 220 V DC		30.047.558	250	
IKD416-31-R	16 A	24 V AC/DC		30.047.559	250	
IKD25-31-R	25 A	230 V AC 220 V DC		30.046.958	250	3
IKD25-31-R	25 A	24 V AC/DC		30.046.959	250	
IKD432-31-R	32 A	230 V AC 220 V DC		30.046.960	250	
IKD432-31-R	32 A	24 V AC/DC		30.046.961	250	
IKD416-30-R	16 A	230 V AC 220 V DC		30.047.560	245	
IKD416-30-R	16 A	24 V AC/DC		30.047.561	245	
IKD25-30-R	25 A	230 V AC 220 V DC		30.046.962	245	3
IKD25-30-R	25 A	24 V AC/DC		30.046.963	245	
IKD432-30-R	32 A	230 V AC 220 V DC		30.046.964	245	
IKD432-30-R	32 A	24 V AC/DC		30.046.965	245	
IKD416-22-R	16 A	230 V AC 220 V DC		30.047.562	250	
IKD416-22-R	16 A	24 V AC/DC		30.047.563	250	
IKD25-22-R	25 A	230 V AC 220 V DC		30.046.966	250	3
IKD25-22-R	25 A	24 V AC/DC		30.046.967	250	
IKD432-22-R	32 A	230 V AC 220 V DC		30.046.968	250	
IKD432-22-R	32 A	24 V AC/DC		30.046.969	250	
IKD416-04-R	16 A	230 V AC 220 V DC		30.047.564	250	
IKD416-04-R	16 A	24 V AC/DC		30.047.565	250	
IKD25-04-R	25 A	230 V AC 220 V DC		30.046.970	250	3
IKD25-04-R	25 A	24 V AC/DC		30.046.971	250	
IKD432-04-R	32 A	230 V AC 220 V DC		30.046.972	250	
IKD432-04-R	32 A	24 V AC/DC		30.046.973	250	

AC-1 acc. to IEC/EN 60947-4-1 (2-pole, 1 module)

AC

Type	Rated current I _n	Control voltage at 50/60 Hz	Wiring diagram	Ordering No.	Weight (g)	Packaging (pcs)
IKA216-20-T	16 A	230 V		30.047.566	130	6
IKA20-20-T	20 A	230 V		30.046.974	130	
IKA225-20-T	25 A	230 V		30.046.975	130	
IKA232-20-T	32 A	230 V		30.046.976	130	
IKA216-11-T	16 A	230 V		30.047.567	130	6
IKA20-11-T	20 A	230 V		30.046.977	130	
IKA225-11-T	25 A	230 V		30.046.978	130	
IKA232-11-T	32 A	230 V		30.046.979	130	
IKA216-10-T	16 A	230 V		30.047.568	125	6
IKA20-10-T	20 A	230 V		30.046.980	125	
IKA225-10-T	25 A	230 V		30.046.981	125	
IKA232-10-T	32 A	230 V		30.046.982	125	
IKA216-01-T	16 A	230 V		30.047.569	125	6
IKA20-01-T	20 A	230 V		30.046.983	125	
IKA225-01-T	25 A	230 V		30.046.984	125	
IKA232-01-T	32 A	230 V		30.046.985	125	
IKA216-02-T	16 A	230 V		30.047.570	130	6
IKA20-02-T	20 A	230 V		30.046.986	130	
IKA225-02-T	25 A	230 V		30.046.987	130	
IKA232-02-T	32 A	230 V		30.046.988	130	

AC-1 acc. to IEC/EN 60947-4-1 (4-pole, 2 modules)

AC

Type	Rated current I _n	Control voltage at 50/60 Hz	Wiring diagram	Ordering No.	Weight (g)	Packaging (pcs)
IKA416-40-T	16 A	230 V		30.047.571	230	3
IKA25-40-T	25 A	230 V		30.046.989	230	
IKA432-40-T	32 A	230 V		30.046.990	230	
IKA416-31-T	16 A	230 V		30.047.572	230	3
IKA25-31-T	25 A	230 V		30.046.991	230	
IKA432-31-T	32 A	230 V		30.046.992	230	
IKA416-30-T	16 A	230 V		30.047.573	225	3
IKA25-30-T	25 A	230 V		30.046.993	225	
IKA432-30-T	32 A	230 V		30.046.994	225	
IKA416-22-T	16 A	230 V		30.047.574	230	3
IKA25-22-T	25 A	230 V		30.046.995	230	
IKA432-22-T	32 A	230 V		30.046.996	230	
IKA416-04-T	16 A	230 V		30.047.575	230	3
IKA25-04-T	25 A	230 V		30.046.997	230	
IKA432-04-T	32 A	230 V		30.046.998	230	

AC-1 acc. to IEC/EN 60947-4-1 (2-pole, 1 module)

AC/DC

Type	Rated current I _n	Control voltage	Wiring diagram	Ordering No.	Weight (g)	Packaging (pcs)		
IKD216-20-T	16 A	230 V AC 220 V DC		30.047.576	130	6		
IKD20-20-T	20 A	230 V AC 220 V DC		30.046.999	130			
IKD225-20-T	25 A	230 V AC 220 V DC		30.047.000	130			
IKD232-20-T	32 A	230 V AC 220 V DC		30.047.001	130			
IKD216-11-T	16 A	230 V AC 220 V DC			30.047.577		130	6
IKD20-11-T	20 A	230 V AC 220 V DC			30.047.002		130	
IKD225-11-T	25 A	230 V AC 220 V DC	30.047.003		130			
IKD232-11-T	32 A	230 V AC 220 V DC	30.047.004		130			
IKD216-10-T	16 A	230 V AC 220 V DC			30.047.578	125	6	
IKD20-10-T	20 A	230 V AC 220 V DC			30.047.005	125		
IKD225-10-T	25 A	230 V AC 220 V DC		30.047.006	125			
IKD232-10-T	32 A	230 V AC 220 V DC		30.047.007	125			
IKD216-01-T	16 A	230 V AC 220 V DC			30.047.579	125		6
IKD20-01-T	20 A	230 V AC 220 V DC			30.047.008	125		
IKD225-01-T	25 A	230 V AC 220 V DC	30.047.009		125			
IKD232-01-T	32 A	230 V AC 220 V DC	30.047.010		125			
IKD216-02-T	16 A	230 V AC 220 V DC			30.047.580	130	6	
IKD20-02-T	20 A	230 V AC 220 V DC			30.047.011	130		
IKD225-02-T	25 A	230 V AC 220 V DC		30.047.012	130			
IKD232-02-T	32 A	230 V AC 220 V DC		30.047.013	130			

AC-1 acc. to IEC/EN 60947-4-1 (4-pole, 2 modules)

AC/DC

Type	Rated current I _n	Control voltage	Wiring diagram	Ordering No.	Weight (g)	Packaging (pcs)
IKD416-40-T	16 A	230 V AC 220 V DC		30.047.581	250	3
IKD25-40-T	25 A	230 V AC 220 V DC		30.047.014	250	
IKD432-40-T	32 A	230 V AC 220 V DC		30.047.015	250	
IKD416-31-T	16 A	230 V AC 220 V DC		30.047.582	250	3
IKD25-31-T	25 A	230 V AC 220 V DC		30.047.016	250	
IKD432-31-T	32 A	230 V AC 220 V DC		30.047.017	250	
IKD416-30-T	16 A	230 V AC 220 V DC		30.047.583	245	3
IKD25-30-T	25 A	230 V AC 220 V DC		30.047.018	245	
IKD432-30-T	32 A	230 V AC 220 V DC		30.047.019	245	
IKD416-22-T	16 A	230 V AC 220 V DC		30.047.584	250	3
IKD25-22-T	25 A	230 V AC 220 V DC		30.047.020	250	
IKD432-22-T	32 A	230 V AC 220 V DC		30.047.021	250	
IKD416-04-T	16 A	230 V AC 220 V DC		30.047.585	250	3
IKD25-04-T	25 A	230 V AC 220 V DC		30.047.022	250	
IKD432-04-T	32 A	230 V AC 220 V DC		30.047.023	250	

General Use acc. to UL 60947-4-1 (2-pole, 1 module)

20 A

AC

Type	Rated current I _n	Control voltage at 50/60 Hz	Wiring diagram	Ordering No.	Weight (g)	Packaging (pcs)
IKA220-20	20 A	230 V		30.046.825	130	6
IKA220-20		120 V		30.047.024	130	
IKA220-20		24 V		30.047.025	130	
IKA220-11	20 A	230 V		30.047.289	130	6
IKA220-11		120 V		30.047.026	130	
IKA220-11		24 V		30.047.027	130	
IKA220-10	20 A	230 V		30.047.290	130	6
IKA220-10		120 V		30.047.028	125	
IKA220-10		24 V		30.047.029	125	
IKA220-01	20 A	230 V		30.047.291	130	6
IKA220-01		120 V		30.047.030	125	
IKA220-01		24 V		30.047.031	125	
IKA220-02	20 A	230 V		30.047.292	130	6
IKA220-02		120 V		30.047.032	130	
IKA220-02		24 V		30.047.033	130	

General Use acc. to UL 60947-4-1 (4-pole, 2 modules)

25 A
AC

Type	Rated current I _n	Control voltage at 50/60 Hz	Wiring diagram	Ordering No.	Weight (g)	Packaging (pcs)
IKA425-40	25 A	230 V		30.046.827	230	3
IKA425-40		120 V		30.047.034	230	
IKA425-40		24 V		30.047.035	230	
IKA425-31	25 A	230 V		30.047.293	230	3
IKA425-31		120 V		30.047.036	230	
IKA425-31		24 V		30.047.037	230	
IKA425-30	25 A	230 V		30.047.294	225	3
IKA425-30		120 V		30.047.038	225	
IKA425-30		24 V		30.047.039	225	
IKA425-22	25 A	230 V		30.047.295	230	3
IKA425-22		120 V		30.047.040	230	
IKA425-22		24 V		30.047.041	230	
IKA425-04	25 A	230 V		30.047.296	230	3
IKA425-04		120 V		30.047.042	230	
IKA425-04		24 V		30.047.043	230	

General Use acc. to UL 60947-4-1 (4-pole, 3 modules)

AC

Type	Rated current I _n	Control voltage at 50/60 Hz	Wiring diagram	Ordering No.	Weight (g)	Packaging (pcs)	
IKA440-40	40 A	230 V		30.045.700	350	5	
IKA440-40		120 V		30.045.612			350
IKA440-40		24 V		30.045.613			350
IKA463-40	63 A	230 V		30.045.592	350	5	
IKA463-40		120 V		30.045.614			350
IKA463-40		24 V		30.045.615			350
IKA440-31	40 A	230 V		30.045.701	350	5	
IKA440-31		120 V		30.045.616			350
IKA440-31		24 V		30.045.617			350
IKA463-31	63 A	230 V		30.045.702	350	5	
IKA463-31		120 V		30.045.618			350
IKA463-31		24 V		30.045.619			350
IKA440-30	40 A	230 V		30.045.703	340	5	
IKA440-30		120 V		30.045.620			340
IKA440-30		24 V		30.045.621			340
IKA463-30	63 A	230 V		30.045.704	340	5	
IKA463-30		120 V		30.045.622			340
IKA463-30		24 V		30.045.623			340

General Use acc. to UL 60947-4-1 (4-pole, 3 modules)

AC

Type	Rated current I _n	Control voltage at 50/60 Hz	Wiring diagram	Ordering No.	Weight (g)	Packaging (pcs)	
IKA440-22	40 A	230 V		30.045.705	350	5	
IKA440-22		120 V		30.045.624			350
IKA440-22		24 V		30.045.625			350
IKA463-22	63 A	230 V		30.045.706	350	5	
IKA463-22		120 V		30.045.626			350
IKA463-22		24 V		30.045.627			350
IKA440-04	40 A	230 V		30.045.707	350	5	
IKA440-04		120 V		30.045.628			350
IKA440-04		24 V		30.045.629			350
IKA463-04	63 A	230 V		30.045.708	350	5	
IKA463-04		120 V		30.045.630			350
IKA463-04		24 V		30.045.631			350

General Use acc. to UL 60947-4-1 (2-pole, 1 module)

20 A
AC/DC

Type	Rated current I _N	Control voltage	Wiring diagram	Ordering No.	Weight (g)	Packaging (pcs)	
IKD220-20	20 A	230 V AC 220 V DC		30.046.826	130	6	
IKD220-20	20 A	120 V AC 110 V DC		30.047.044	130		
IKD220-20	20 A	24 V AC/DC		30.047.045	130		
IKD220-11	20 A	230 V AC 220 V DC		30.047.297	130		
IKD220-11	20 A	120 V AC 110 V DC		30.047.046	130		
IKD220-11	20 A	24 V AC/DC		30.047.047	130		
IKD220-10	20 A	230 V AC 220 V DC		30.047.298	125	6	
IKD220-10	20 A	120 V AC 110 V DC		30.047.048	125		
IKD220-10	20 A	24 V AC/DC		30.047.049	125		
IKD220-01	20 A	230 V AC 220 V DC		30.047.299	125		6
IKD220-01	20 A	120 V AC 110 V DC		30.047.050	125		
IKD220-01	20 A	24 V AC/DC		30.047.051	125		
IKD220-02	20 A	230 V AC 220 V DC		30.047.300	130	6	
IKD220-02	20 A	120 V AC 110 V DC		30.047.052	130		
IKD220-02	20 A	24 V AC/DC		30.047.053	130		

General Use acc. to UL 60947-4-1 (4-pole, 2 modules)

25 A
AC/DC

Type	Rated current I _N	Control voltage	Wiring diagram	Ordering No.	Weight (g)	Packaging (pcs)	
IKD425-40	25 A	230 V AC 220 V DC		30.046.828	250	6	
IKD425-40	25 A	120 V AC 110 V DC		30.047.054	250		
IKD425-40	25 A	24 V AC/DC		30.047.055	250		
IKD425-31	25 A	230 V AC 220 V DC		30.047.301	250		6
IKD425-31	25 A	120 V AC 110 V DC		30.047.056	250		
IKD425-31	25 A	24 V AC/DC		30.047.057	250		
IKD425-30	25 A	230 V AC 220 V DC		30.047.302	245	6	
IKD425-30	25 A	120 V AC 110 V DC		30.047.058	245		
IKD425-30	25 A	24 V AC/DC		30.047.059	245		

General Use acc. to UL 60947-4-1 (4-pole, 2 modules)

25 A
AC/DC

Type	Rated current I _N	Control voltage	Wiring diagram	Ordering No.	Weight (g)	Packaging (pcs)	
IKD425-22	25 A	230 V AC 220 V DC		30.047.303	250	6	
IKD425-22	25 A	120 V AC 110 V DC		30.047.060	250		
IKD425-22	25 A	24 V AC/DC		30.047.061	250		
IKD425-04	25 A	230 V AC 220 V DC		30.047.304	250		6
IKD425-04	25 A	120 V AC 110 V DC		30.047.062	250		
IKD425-04	25 A	24 V AC/DC		30.047.063	250		

General Use acc. to UL 60947-4-1 (4-pole, 3 modules)



Type	Rated current I_n	Control voltage	Wiring diagram	Ordering No.	Weight (g)	Packaging (pcs)
IKD440-40	40 A	230 V AC 220 V DC		30.045.709	420	5
IKD440-40	40 A	120 V AC 110 V DC		30.045.632	420	
IKD440-40	40 A	24 V AC/DC		30.045.633	420	
IKD463-40	63 A	230 V AC 220 V DC		30.045.593	420	5
IKD463-40	63 A	120 V AC 110 V DC		30.045.634	420	
IKD463-40	63 A	24 V AC/DC		30.045.635	420	
IKD440-31	40 A	230 V AC 220 V DC		30.045.710	420	5
IKD440-31	40 A	120 V AC 110 V DC		30.045.636	420	
IKD440-31	40 A	24 V AC/DC		30.045.637	420	
IKD463-31	63 A	230 V AC 220 V DC		30.045.711	420	5
IKD463-31	63 A	120 V AC 110 V DC		30.045.638	420	
IKD463-31	63 A	24 V AC/DC		30.045.639	420	
IKD440-30	40 A	230 V AC 220 V DC		30.045.712	410	5
IKD440-30	40 A	120 V AC 110 V DC		30.045.640	410	
IKD440-30	40 A	24 V AC/DC		30.045.641	410	
IKD463-30	63 A	230 V AC 220 V DC		30.045.713	410	5
IKD463-30	63 A	120 V AC 110 V DC		30.045.642	410	
IKD463-30	63 A	24 V AC/DC		30.045.643	410	
IKD440-22	40 A	230 V AC 220 V DC		30.045.714	420	5
IKD440-22	40 A	120 V AC 110 V DC		30.045.644	420	
IKD440-22	40 A	24 V AC/DC		30.045.645	420	
IKD463-22	63 A	230 V AC 220 V DC		30.045.715	420	5
IKD463-22	63 A	120 V AC 110 V DC		30.045.646	420	
IKD463-22	63 A	24 V AC/DC		30.045.647	420	
IKD440-04	40 A	230 V AC 220 V DC		30.045.594	420	5
IKD440-04	40 A	120 V AC 110 V DC		30.045.648	420	
IKD440-04	40 A	24 V AC/DC		30.045.649	420	

Список переключателей и положение групп контактов

AC-21 acc. to IEC/EN 60947-3 (2-pole, 1 module)

Type	Rated current I_n	Wiring diagram	Ordering No.	Weight (g)	Packaging (pcs)
IKS220-20-R	20 A		30.047.064	55	6
IKS225-20-R	25 A		30.047.065	55	
IKS232-20-R	32 A		30.047.066	55	
IKS220-11-R	20 A		30.047.067	55	6
IKS225-11-R	25 A		30.047.068	55	
IKS232-11-R	32 A		30.047.069	55	

AC-21 acc. to IEC/EN 60947-3 (4-pole, 2 modules)

Type	Rated current I_n	Wiring diagram	Ordering No.	Weight (g)	Packaging (pcs)
IKS420-40-R	20 A		30.047.070	105	3
IKS425-40-R	25 A		30.047.071	105	
IKS432-40-R	32 A		30.047.072	105	
IKS420-31-R	20 A		30.047.073	105	3
IKS425-31-R	25 A		30.047.074	105	
IKS432-31-R	32 A		30.047.075	105	
IKS420-22-R	20 A		30.047.076	105	3
IKS425-22-R	25 A		30.047.077	105	
IKS432-22-R	32 A		30.047.078	105	

AC-21 acc. to IEC/EN 60947-3 (2-pole, 1 module)

Type	Rated current I_n	Wiring diagram	Ordering No.	Weight (g)	Packaging (pcs)
IKS220-20-T	20 A		30.047.079	55	6
IKS225-20-T	25 A		30.047.080	55	
IKS232-20-T	32 A		30.047.081	55	
IKS220-11-T	20 A		30.047.082	55	6
IKS225-11-T	25 A		30.047.083	55	
IKS232-11-T	32 A		30.047.084	55	

AC-21 acc. to IEC/EN 60947-3 (4-pole, 2 modules)

Type	Rated current I_n	Wiring diagram	Ordering No.	Weight (g)	Packaging (pcs)
IKS420-40-T	20 A		30.047.085	105	3
IKS425-40-T	25 A		30.047.086	105	
IKS432-40-T	32 A		30.047.087	105	
IKS420-31-T	20 A		30.047.088	105	3
IKS425-31-T	25 A		30.047.089	105	
IKS432-31-T	32 A		30.047.090	105	
IKS420-22-T	20 A		30.047.091	105	3
IKS425-22-T	25 A		30.047.092	105	
IKS432-22-T	32 A		30.047.093	105	

Аксессуары

Дополнительный вентиляционный модуль IKV
(предотвращает перегрев контакторов при установке вплотную в ряд):



Type	Ordering No.	Weight (g)	Packaging (pcs)
IKV	37.425.296	13	1

Уплотнительные крышки:

1 модульная

Type	Ordering No.	Weight (g)	Packaging (pcs)
IK20-PP	37.425.061	1	2



2 модульная

Type	Ordering No.	Weight (g)	Packaging (pcs)
IK25-PP	37.425.062	2	2



3 модульная

Type	Ordering No.	Weight (g)	Packaging (pcs)
IK40/63-PP	37.423.463	3	2



Вспомогательные блок-контакты:



Auxiliary switch - AC-15 acc. to IEC/EN 60947-5-1 (2-pole, 1/4 module)

Type	Rated current I _n	Wiring diagram					Ordering No.	Weight (g)	Packaging (pcs)
		-20	-11	-01	-10	-02			
IKN20	6 A						38.046.002	30	1
IKN11	6 A						38.046.004	30	
IKN10	6 A						38.046.036	25	
IKN01	6 A						38.046.037	30	
IKN02	6 A						38.046.003	30	

Auxiliary switch - Ratings acc. to UL 580 (2-pole, 1/4 module)

Type	Rating code	Wiring diagram			Ordering No.	Weight (g)	Packaging (pcs)
		-20	-11	-02			
IKN20UL	C300, Q300				38.046.050	30	1
IKN11UL	C300, Q300				38.046.049	30	
IKN02UL	C300, Q300				38.046.051	30	

Шины (4ех фазные, для контакторов до 32 A):

4-phase busbars for installation contactors up to 32 A - insulated

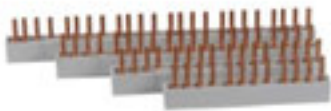

Type	Module width	Length (mm)	Ordering No.	Weight (g)	Packaging (pcs)
L/32-8P	4	66	786.015.051	60	10
L/32-12P	6	98	786.015.052	86	
L/32-16P	8	138	786.015.053	114	
L/32-20P	10	173	786.015.054	141	
L/32-24P	12	208	786.015.055	169	

Клемма (1 pin) для контакторов до 32 А:



Single pin terminals for installation contactors up to 32 A - insulated

Type	Pin length	Cross-section rigid/flexible (mm ²)	Screw	Ordering No.	Weight (g)	Packaging (pcs)
S/32-1P	13.5/32 (total)	6-25/4-16	P22	786.015.060	12	25

Клемма (2 pin) для контакторов 40 и 63 А:



Double pin terminals for installation contactors 40 and 63 A - insulated terminals for parallel connection

Type	Pin length	Cross-section rigid/flexible (mm ²)	Screw	Ordering No.	Weight (g)	Packaging (pcs)
S/63-2P	15	6-50/4-35	P22	786.015.061	22	25

Схема установки аксессуаров

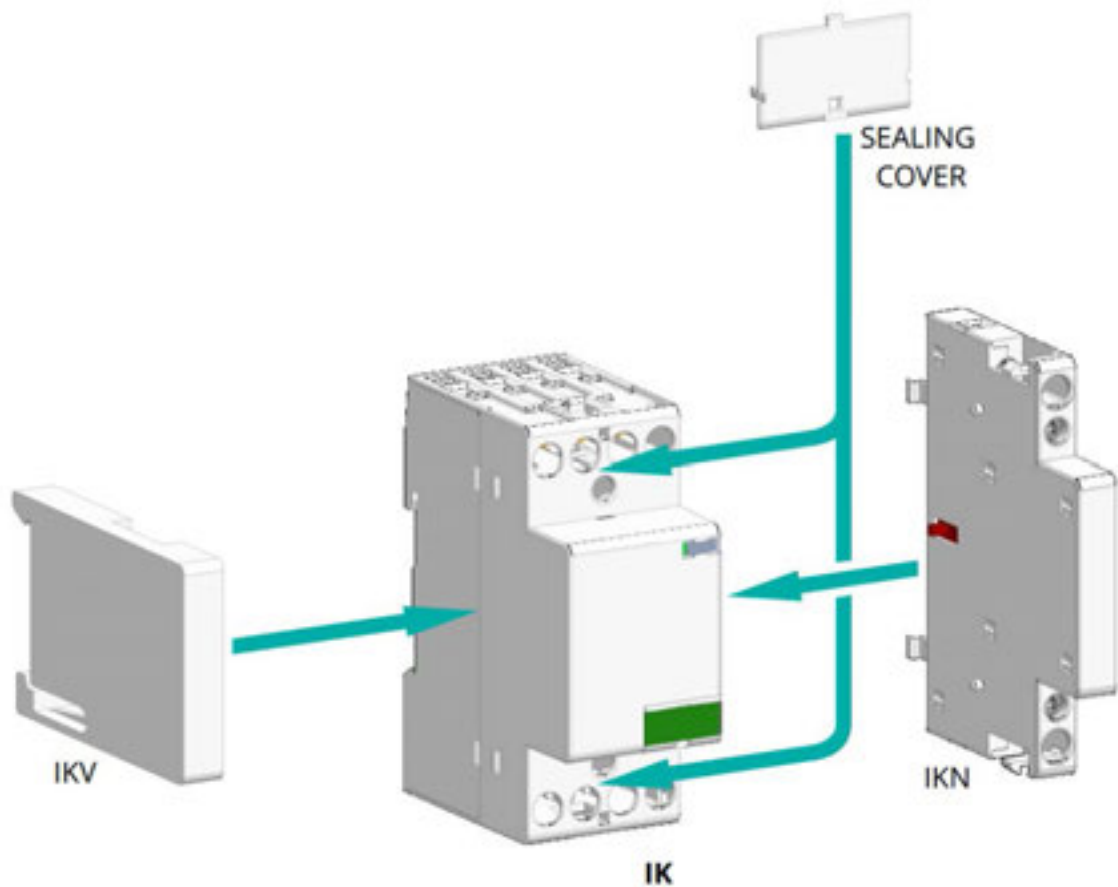

Габаритные чертежи

IK21

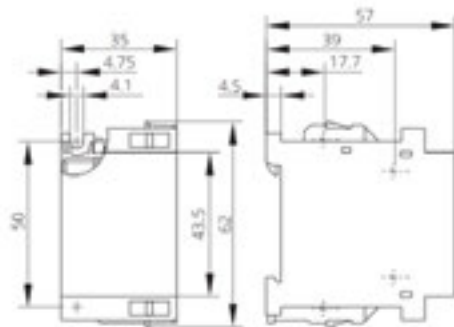

IKA216, IKD216
IKA20, IKD20
IKA225, IKD225
IKA232, IKD232
IKA140-1P
IKD140-1P

IKA416, IKD416
IKA25, IKD25
IKA432, IKD432
IKA240-2P, IKD240-2P

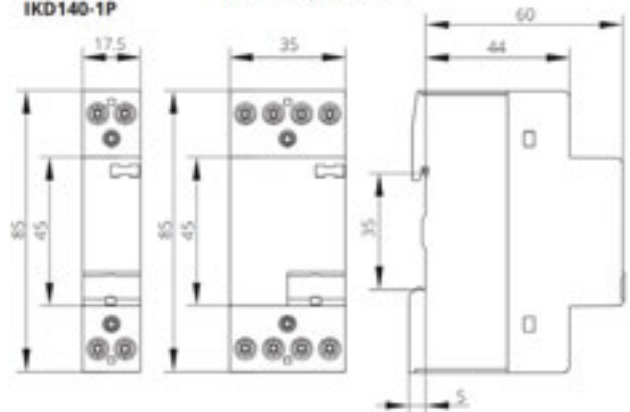

IKA216-R, IKD216-R
IKA20-R, IKD20-R
IKA225-R, IKD225-R
IKA232-R, IKD232-R

IKA416-R, IKD416-R, IKA416-T, IKD416-T
IKA25-R, IKD25-R, IKA25-T, IKD25-T
IKA432-R, IKD432-R, IKA432-T, IKD432-T
IKS420-R, IKS425-R, IKS432-R
IKS420-T, IKS425-T, IKS432-T

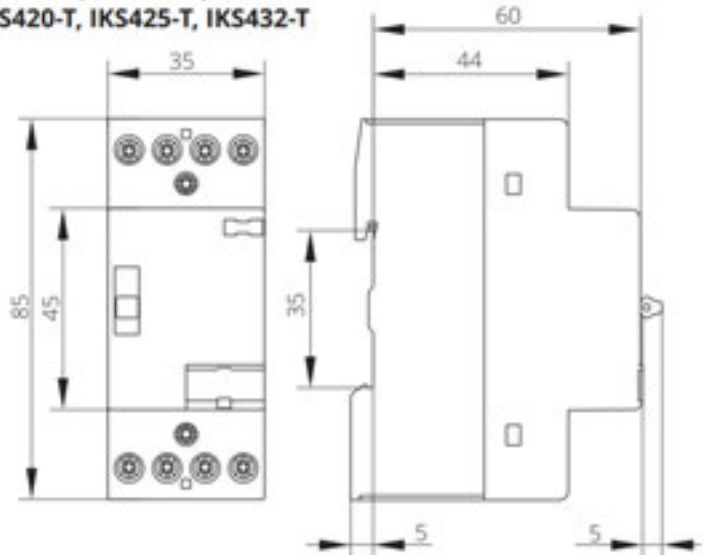
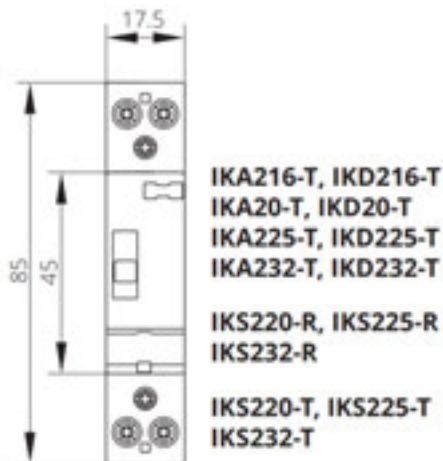

IKA220 (UL), IKA425 (UL)
IKD220 (UL), IKD425 (UL)

IKA440 (UL), IKD440 (UL)
IKA463 (UL), IKD463 (UL)

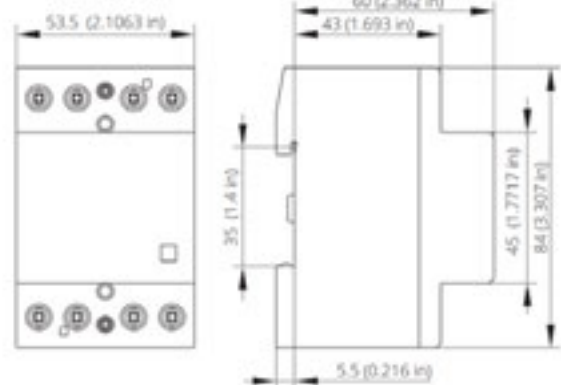
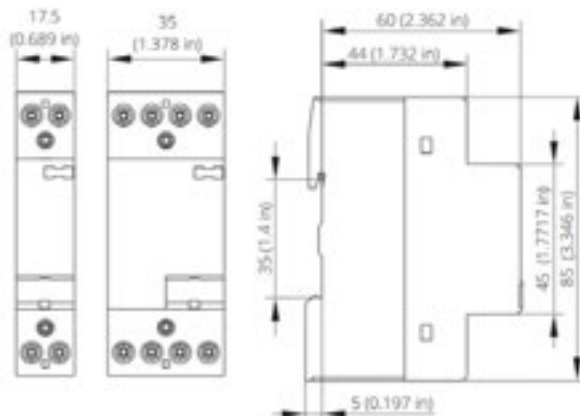

IK40, IK63
IKA40, IKA63

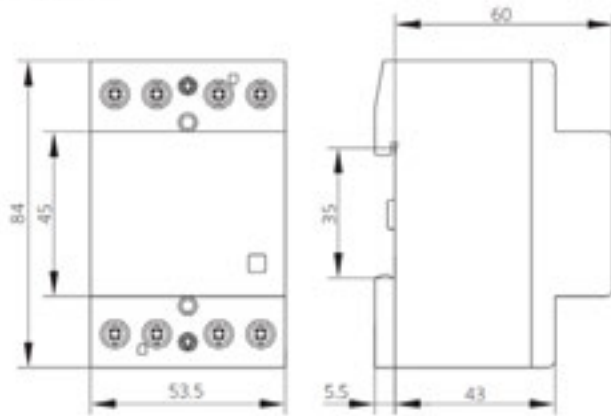

IKV

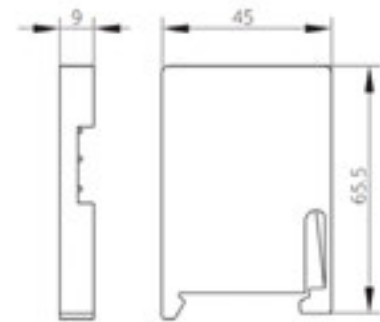

IKN

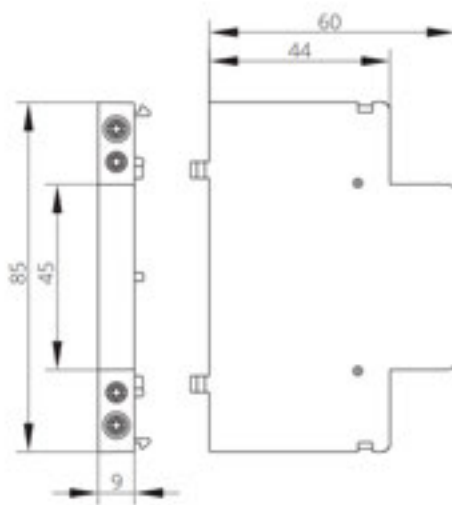

IKN-UL

